



**2024 – Over 3.4 Million BACS Modules in the Field !**

BACS® - Battery Analysis & Care System – with Generation 3, BACS has assumed market leadership for stationary BMS Systems in the western world. BACS monitors and controls more than 2 million batteries within the most critical applications in airports, military and data centers.

BACS is one of the few true battery management systems on the market, something often compared to simple battery monitoring systems. The most important differences to such systems, also called "BMS", are:

- ✓ **BACS maximizes the battery system capacity by up to 20% and the operating time of cells/batteries by up to 50% compared to a battery monitoring system and thus massively improves the efficiency and reliability of stationary battery systems.**
- ✓ **BACS is the first battery management system for all types of lead/nickel/cadmium based batteries on the market which can calculate and display the individual capacity of each cell/block.**
- ✓ **BACS is also suitable for use on lithium based batteries, especially for LiFePo4 and LTE cells with large capacities**
- ✓ **BACS prevents system malfunctions due to unnoticed cell/battery failures**
- ✓ **BACS is 100% developed and produced in Europe and the USA and is the first choice for all critical data centers in the western world and in many cases tendered as a reference system.**

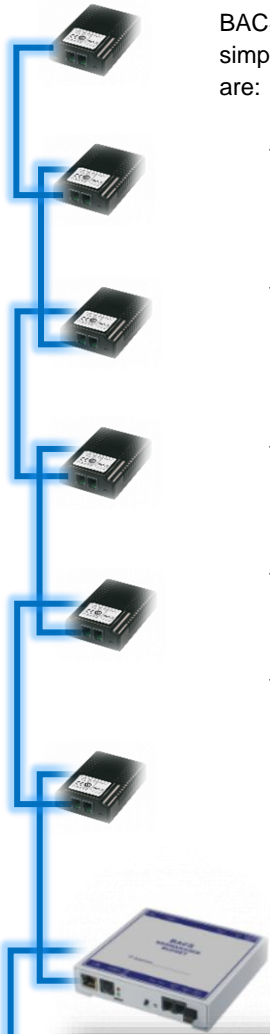

... Maximized Charge ...

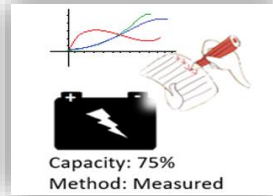

... Realtime Battery Capacity ...

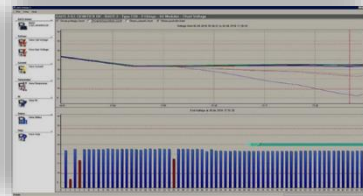

... Professional Software ...





***BACS is the most successful and powerful system for stationary battery systems, all connected devices for power supply and sensor technology in battery and UPS rooms.***

BACS® is the safest battery management system on the market, able additionally to monitor and manage the surrounding infrastructure. BACS® starts with measurement results from the direct environment of a battery such as voltage, impedance, temperature, humidity, acid level, hydrogen gas concentration, pressure, etc. BACS® can additionally take control of external hardware such as complex climate control systems and emergency venting, if required. Even sensors and contacts to and from third-party systems can be reliably managed by BACS®, allowing it to integrate with fire alarm systems, for example. BACS also interfaces with all types of UPSs, inverters, transfer switches, generators, and other equipment powered by batteries. What's more, BACS® can transparently integrate into all kinds of network structures such as BACnet, SNMP or MODBUS and optionally also into other fieldbuses and adapt to existing safety guidelines.

*BACS maintains an assured and competent overview even in a complex emergency situation.*

Similar to a programmable logic controller (PLC), BACS® (and the CS141) can be programmed to manage automatic emergency procedures. Core functions here include management of third-party devices (other UPS SNMP cards or other sensors), active on-site emergency management, and a comprehensive emergency notification system that provides all necessary information immediately when needed so that crisis response teams can react as quickly as possible.

**BACS delivers improved economics and safety and is not a "luxury" like battery monitoring systems - this is largely due to "balancing":**

To optimize charging behavior, BACS® relies on our self-developed passive control method - known as "Equalizing" in Europe and "Balancing" worldwide. This allows the charging voltage of all batteries to be kept within the optimal values specified by the battery manufacturer. **This control has a massive influence on the behavior of the batteries and thus on the cost and reliability of the entire system.**

**The lifetime of all batteries is the costly part of any battery based UPS solution:** If one battery fails, then usually **all** batteries have to be replaced. The lifetime of such a battery network in a UPS is 50-60% of the stated design life of battery manufacturers. This unacceptably short lifetime can be improved enormously by Equalizing/Balancing. With this technique, each individual battery is kept at the optimal voltage level to avoid overcharging or undercharging. The main reason for premature failure of batteries in stationary systems is thus eliminated. That this has an additional improvement in the capacity of a battery system is a welcome side effect, and verifiable: capacity measurements of end customers have shown that systems using BACS have up to 20% higher capacity compared to comparative systems without BACS batteries. The reason for this is simply explained: batteries that are not undercharged reach 100% capacity and now provide this increased power during a capacity test.

BACS® has been proven to extend the service life of all batteries in high voltage string applications, so that the specified Design Life can actually be achieved. This is something that no Battery Monitoring System can do. A monitoring system can only display data, and has no economic effect and is therefore a pure "luxury" that increases the actual costs - without any positive effect on safety or improvement in costs.

BACS® can be integrated into any network, and independently collects all operationally relevant values with regards to voltage, temperature, internal resistance, etc.. In addition, BACS® can actively control the individual charging behavior for each battery or even each cell within a battery string of UPS storage systems and **determine the capacity**. Where other systems have to cumulate laboriously and round up or down or estimate, BACS can use a better calculation basis because of balancing and thus achieve equivalent capacity measurements without costly additional measurement technology. BACS is the ideal system for all types of lead/NiCd acid batteries (open / wet cells, maintenance free, gel, AGM etc.) and also for most types of Li-ion batteries.



**BACS® Features**

● **Equalization/Voltage Balancing**

The unique BACS® "Equalization" or "Balancing" manages the voltage supply for each battery or cell. BACS® monitors the charger's charge voltage level and takes an active role in distributing the charge current, pulling all managed batteries to the average voltage provided by the battery charger - to within 0.01 volts!

**This process ensures that all batteries / cells reach the full state of charge and, in addition to the optimum capacity, the service life increases.**



Batteries managed by BACS® achieve the ideal and harmonized charging curve within a battery string. Equalizing (Balancing) prevents unintentional overcharging of batteries and thus also the causes of gassing, dehydration and thermal problems. At the same time, BACS® Equalizing (Balancing) effectively prevents unintentional undercharging and associated sulfation and capacity loss. Requirement is the correct setting of the charger (UPS) for the battery type / specification of the manufacturer, BACS ensures that this target voltage is maintained.

*BACS uses the passive control method "Balancing" for the control of the batteries*

In the first step, BACS determines the individual voltage values for each cell or battery and thus determines the average voltage for the entire battery string as the so-called "target voltage" - batteries deviating from this target voltage can be identified and are now included in the regulation.

- If the voltage readings on a cell deviate upwards, there is a risk of overcharging - BACS will divert the excess charge current via its own bypass and convert it to heat, keeping the battery at the optimum state of charge.
- If the values of a battery fall below the target value, there is a risk of undercharging. Because the bypass is activated for all "good" batteries, the charge voltage and current for all other batteries that are too low increases significantly - the required charge current is supplied to the corresponding battery, because the weighting of the charge retention voltage is shifted to the batteries that require more charge.

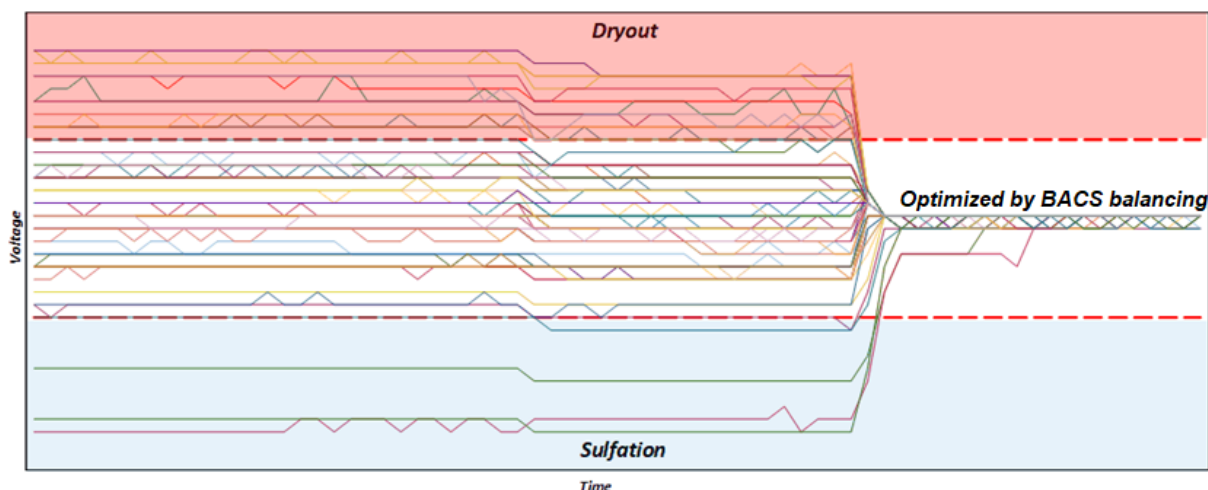

With this method of balancing, such batteries can be brought into the optimal voltage range at the same time, even though they have different charging needs. The accuracy of this process is 1/100 volt within one battery string.



● **BACS® - Improve overall battery performance and service life**

**Optimized State of Charge: SOC:** Thanks to the Equalization (Balancing) process, BACS® guarantees up to 100% SOC with optimal protection of the batteries, thus optimizing the performance of your installation.

**Increasing the Service Life (State of Health: SOH):** The service life of batteries within high-voltage applications is determined by the weakest cell in the network and is greatly shortened by incorrect charging behavior. Batteries usually reach only 50-60% of the time period specified by manufacturers as "Design Life". BACS® keeps each battery at its optimal voltage level. This optimizes the charging process and ensures an optimal health status of each cell/block. This creates the basis for achieving the "Design Life" specified by the manufacturer in the first place.

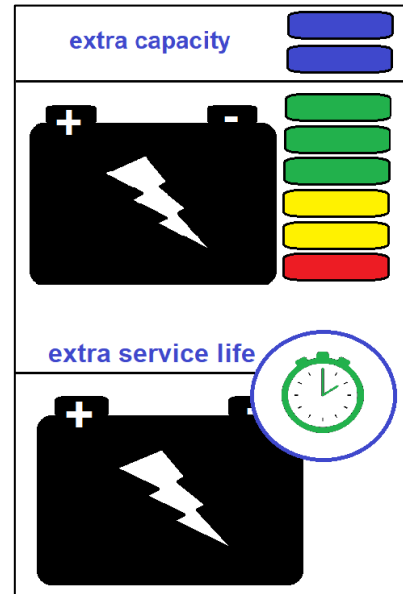

● **BACS® - NEW - Battery capacity measurement for each cell / Block !**

BACS® is the first system on the market to offer a new measurement method to determine the capacity of each individual battery.

Where other systems cannot provide any values for the battery capacity at all - or if, then can only deliver the theoretical capacity of a battery as an estimate in a complicated way, BACS uses a partially newly developed measurement method to individually record the states of charge of a battery - at a significantly lower cost than any other system on the market!

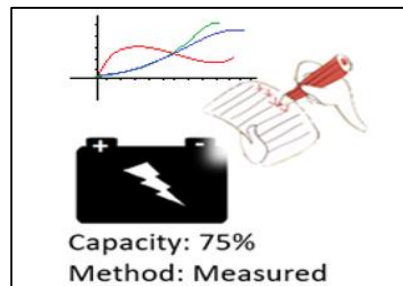

String 1 LONG 5/2017						
No.	Volt. [V]	Temp. [°C]	Ri. [mΩ]	Charge [%]	Equalize	Status
1	13.59	24.1	21.42	100%		
2	13.59	24.7	22.10	100%		
3	13.59	25.0	21.12	100%		
4	13.59	24.7	22.20	100%		



- **BACS® - Pro-Active protection of the whole string**

Not only damaged batteries have a direct effect on the directly neighboring batteries - another known phenomenon is that due to the charging behavior of batteries, new and old batteries cannot be operated together - one must generally replace all batteries in a string should an older block need to be replaced.

BACS® regulates the charging process individually according to the demand / internal resistance of the respective battery and thus prevents batteries from affecting and damaging each other during charging. Due to this individual treatment of each battery, defective or old batteries can be exchanged and thus "new" and "old" can be operated together.

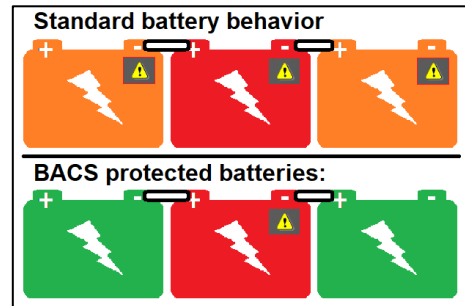

- **Early detection of battery failures**

Typical problems like sulfation, corrosion, outgassing, dehydration and thermal runaway are indicated early by irregularities in measurement data of affected batteries - warning signs can be found in voltage values, internal resistances, temperature developments, string currents, balancing power or battery capacity. With its measurement data, BACS offers far more possibilities than other BMS systems to detect and display these hidden indications so that maintenance windows can be planned in time.

- **Stratification - A constant problem with stationary batteries**

In batteries at rest, the chemicals tend to arrange themselves in layers within a battery. The more liquid contained within the electrolyte, the stronger this effect. As a consequence, internal resistance and voltages gradually shift - the batteries slowly drift apart. Since this stratification in a battery is no longer fully reversible after a certain point, it is recommended to regularly run a complete discharge/charge cycle, i.e. to "use" the batteries - this prevents this effect.



**However, exactly this measure is "forbidden" for many UPS users and thus stratification is often unavoidable because an actual power failure occurs too rarely.** BACS® does not prevent this stratification process completely, but slows down the formation of such stratifications considerably. Through equalizing (balancing), there is always a low utilization of the batteries, which makes the stratification process much slower, even without a discharge/charge cycle. This improves the SOH - State of Health - and the reliability of the entire system. This improvement in SOH is based on the improved "reactivity" of the battery which has no stratification problem: BACS balancing allows the batteries to be ready to deliver power more quickly in the event of a power outage than in a system without BACS, where stratification has occurred. **The creeping danger that the UPS does not get enough voltage/current from the batteries and switches off because of undervoltage directly after a power failure is much less when using BACS.** The problem that customers report because a UPS simply switched off due to "battery undervoltage" during a so-called "mains wiper", but took over without problems during a 2nd mains wiper shortly afterwards or a subsequent battery test, **is no longer present with Balancing, because the batteries hardly build up layers and are IMMEDIATELY available to carry the load.**





● BACS® stands for active protection through prevention of THERMAL RUNAWAYS

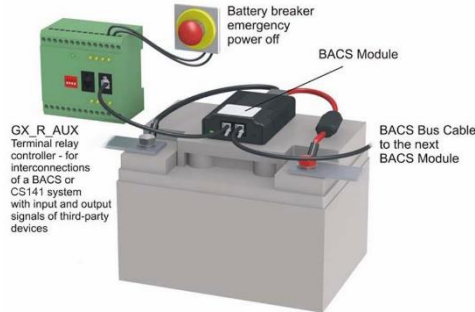

BACS is able to detect a thermal runaway risk by monitoring the cell/block temperatures and, optionally, the current of the string. In case a thermal runaway is detected, the BACS system can automatically trigger the battery breaker to open, thus isolating the battery strings. This principle is in accordance to the International Fire Code 2018 Section 1206.2.10.7 and is mandatory in many US battery installations.

The GX\_R\_AUX module provides 4 relay contacts and 4 digital inputs. Therefore, it is able to control up to 4 breakers. The digital inputs read the battery breaker status and display it in the BACS® web interface. Other alarm devices (for example, audio alarms) may be connected to the outputs or digital inputs of the GX\_R\_AUX.

● BACS® keeps watch and alerts in case of lagging batteries

BACS® monitors the internal resistance of each battery and can therefore detect early signs of battery failure. Also the battery capacity indicator shows early if single cells/batteries become conspicuous. In this way, individual batteries can be replaced in time and thus forms the basis for a stable and long-lasting UPS system.

**GENEREX**

- UPS Monitor
- BACS Monitor
- BACS GX\_R\_AUX
- Sensor Monitor
- Devices
- Services
- System
- Logfile
- Logout admin

Automatic Logout in 12 min  
CS141-SNMP V2.05.12.220305

UPS: ● OK      Sensor: ● 5 - H2 Gasconcentration HighPreAlarm      GX\_R\_AUX: ●      BACS: ● High Impedance

**BACS Monitor**

BACS - Hamburg Testlab 1

● Warning: Impedance High  
● Status: Charging

String 1 LONG 6/2017							String 2 PANASONIC 9/2016							String 3 PANASONIC Mix 2/2014 and 2019						
No.	Volt. [V]	Temp. [°C]	Ri. [mΩ]	Charge [%]	Equalize	Status	No.	Volt. [V]	Temp. [°C]	Ri. [mΩ]	Charge [%]	Equalize	Status	No.	Volt. [V]	Temp. [°C]	Ri. [mΩ]	Charge [%]	Equalize	Status
1	13.59	25.0	21.37	100%		●	21	13.59	24.6	38.90	100%		●	41	13.59	25.6	57.83	100%		●
2	13.59	26.0	22.06	100%		●	22	13.59	26.5	44.44	100%		●	42	13.59	26.3	48.72	100%		●
3	13.59	25.7	21.16	100%		●	23	13.59	26.6	45.23	100%		●	43	13.59	26.5	17.07	100%		●
4	13.59	26.0	22.22	100%		●	24	13.59	26.5	16.98	100%		●	44	13.59	26.5	16.98	100%		●
5	13.59	25.5	21.07	100%		●	25	13.59	26.0	54.17	100%		●	45	13.59	27.0	16.86	100%		●
6	13.59	26.0	22.08	100%		●	26	13.59	26.0	46.42	100%		●	46	13.59	26.5	48.62	100%		●
7	13.59	26.0	21.91	100%		●	27	13.59	27.0	43.10	100%		●	47	13.59	27.0	48.08	100%		●
8	13.59	25.5	22.43	100%		●	28	13.59	26.5	54.57	100%		●	48	13.59	27.5	19.25	100%		●
9	13.59	26.0	22.27	100%		●	29	13.59	26.3	48.90	100%		●	49	13.59	26.9	16.52	100%		●
10	13.59	26.0	21.59	100%		●	30	13.59	26.3	44.61	100%		●	50	13.59	27.0	21.21	100%		●
11	13.59	25.5	22.02	100%		●	31	13.59	26.0	33.47	100%		●	51	13.59	25.4	21.83	100%		●
12	13.59	26.0	22.05	100%		●	32	13.59	26.1	21.47	100%		●	52	13.59	26.0	51.17	100%		●
13	13.59	26.5	21.86	100%		●	33	13.59	27.0	36.92	100%		●	53	13.59	26.4	16.88	100%		●
14	13.59	26.0	22.99	100%		●	34	13.59	26.0	41.96	100%		●	54	13.59	25.7	53.85	100%		●
15	13.59	26.0	21.38	100%		●	35	13.59	26.5	34.90	100%		●	55	13.59	26.0	16.96	100%		●
16	13.59	26.5	21.64	100%		●	36	13.59	27.2	50.32	100%		●	56	13.59	26.5	16.72	100%		●
17	13.59	26.5	21.46	100%		●	37	13.59	26.7	52.27	100%		●	57	13.59	25.6	36.18	100%		●
18	13.59	27.0	21.99	100%		●	38	13.59	28.0	21.60	100%		●	58	13.59	26.5	51.37	100%		●
19	13.59	26.0	21.86	100%		●	39	13.59	25.5	21.36	100%		●	59	13.59	26.5	23.51	100%		●
20	13.59	26.5	21.07	100%		●	40	13.59	26.5	55.97	100%		●	60	13.59	26.0	35.70	100%		●
Σ Voltage 271.84 V							Σ Voltage 271.84 V							Σ Voltage 271.84 V						
13.59 [V] Target Voltage							13.59 [V] Target Voltage							13.59 [V] Target Voltage						
0 [A] DC Current    0.00 [KW] Real Power							0 [A] DC Current    0.00 [KW] Real Power							0 [A] DC Current    0.00 [KW] Real Power						
0 [A] AC Current							0 [A] AC Current							0 [A] AC Current						

The BACS® web server shows the battery status of up to 512 batteries in 16 strings, 16 alarm contacts, 8 analog meters and 1 UPS on one screen and under one network address. Status LEDs (green / yellow / red) and battery capacity show a color change when a battery exceeds the configured thresholds or the capacity approaches a critical limit.



- **Multi-layered configurable alarm behavior**

BACS® continuously compares all measured data with alarm thresholds that can be configured freely. In case of problems, an acoustic, visual or network-based alarm behavior can be configured. BACS® monitors additional UPS relevant data on request and can also integrate external control systems (temperature, humidity, hydrogen, acid level, AC currents, potential free contacts, any kind of third party sensors) depending on the expansion stage.

- **MODBUS/BACnet/PROFIBUS/LONBUS/SNMP...**

BACS® seamlessly integrates into almost all existing building and network management systems and provides all measurement data via MODBUS TCP, BACnet and SNMP, as well as via its own interface (API) and of course via a web server. Optionally other bus systems are available, so additionally a MODBUS RTU via RS232 / RS485 can be provided or adapters for PROFIBUS and LONWORKS can be delivered. BACS does not only provide all battery and sensor readings, also the "consumer" like UPS devices from almost any manufacturer can be evaluated by BACS and included in the battery management and evaluated with the mentioned network/fieldbus protocols. No other system on the market can do this!

- **Email Traps® - Monitoring of all battery and device data of the end customer - without violating IT security standards:**

*Innovative monitoring in the most adverse conditions: Monitor your batteries where other systems fail due to IT security policies or unreliable network connection*

BACS® was developed as a network product to ensure the best possible connection and communication in LAN/WAN/VPN concepts. Outside of networks, however, it becomes difficult - not every end customer is willing to allow a third party VPN/network connection for monitoring. For this reason, we have integrated an additional function in BACS and the UNMS software: The remote monitoring "Email Traps®" of UNMS allows you to passively monitor any BACS installation worldwide via email without violating existing security concepts. Decentralized networks without permanent connection or with special operating conditions can transmit all measured values to the UNMS this way and can be monitored - without the need to involve IT - the only requirement is a valid mail server/service and a deposited mail address somewhere in this world - and the UNMS can display and monitor all BACS and UPS or SENSORMANAGER data.

- **Real-time battery testing thanks to integrated UPS control**

BACS® was developed to manage the UPS and other charging concepts in parallel to the actual battery management. Effects of a UPS battery test can therefore be observed in real time on the batteries:

- Test your emergency measures in real time and risk-free, you know exactly when it could become critical for your UPS, because BACS provides you with the measurement data
- Plan and test your system without risk for the connected system
- Perform battery tests and impedance measurements without compromising the safety of the system

- **Cybersecurity**

The general requirements for a modern WEBMANAGER have changed massively over the years. Battery based UPS systems are no longer an "assistance system", but a central core component within every modern IT infrastructure. As a tribute to the massively changed requirement profiles, the CS141 - and thus also BACS® - has been adapted to the latest network technology, which brings with it numerous new developments in the security area:



- **RADIUS und RADIUS 802.1x**  
This new feature allows administrators to physically disconnect all devices that cannot identify themselves as "authorized" from the network. In addition, local user management is eliminated if desired. Only the access levels of a modern high-security network apply.
- **Remote Syslog**  
The BACS® WEBMANAGER transmits all of its event logs standardized to a central syslog receiver. Due to the possibility to create log files via jobs and to define measured values with variables, administrators can perform the automatic monitoring of their devices via the syslog alone.
- **Advanced User Management**  
The BACS® WEBMANAGER offers freely definable user names and dynamic user roles, which allows personalized access restrictions and the definition of user groups.
- **Contact-based communication for building services**  
"No network uplink is the safest uplink" - true to this motto, even in absolute high security areas without a local network, information can be exchanged with a BACS® WEBMANAGER. Numerous sensors and access points provide the possibility to indicate problems even with simple contact wires. Each alarm point can be configured to operate a contact opener or closer and can be evaluated by a building management system.
- **Modern encryption methods**  
The in-house developed operating system of the CS141 and BACS firmware has numerous possibilities to encrypt the connection between all participants without compromise. Thanks to the regular enhancements of the hardware and software, all future standards and security features are also available for BACS.
- **Gigabit LAN**  
Modern infrastructures require more and more native Gigabit connections, which have been retrofitted with the new CS141 HW161 also for BACS without losing compatibility to older networks. Thus, the BACS® WEBMANAGER is uncompromisingly compatible with the hardware standards of the last 22 years and continues to fit seamlessly even into the most modern infrastructures.

● **The BACSViewer – A Complimentary Tool for Professional Battery Management**

The unique BACS® VIEWER software can do more than simply "fetch" data from the Manager and free local memory for data logging.

The BACS® VIEWER software is a powerful program to analyze and archive battery data of a BACS system. It integrates additional documents such as drawings, reports, warranty certificates, maintenance schedules, handouts for technical staff and facilitates the management of many BACS systems and thus thousands of batteries with one central software. With the BACS® VIEWER software, maintenance tasks can be scheduled, battery trends can be determined, faulty batteries are detected and status reports are generated automatically.

*Battery chemistry irregularities are harbingers of a problem - BACS makes the "battery" gray area a thing of the past for system-critical applications!*

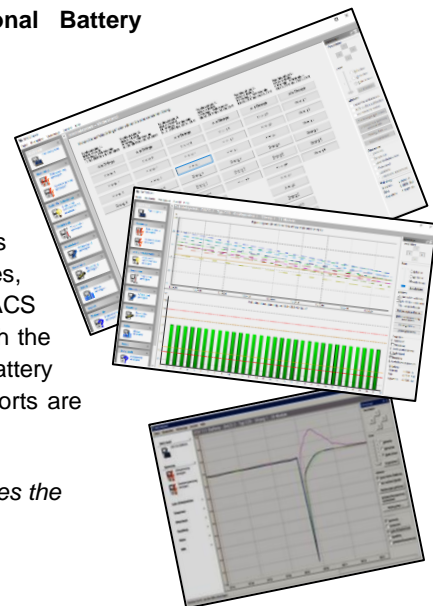





Example: Detecting a defective battery

The BACS® VIEWER shows the individual battery voltage of all accumulators at the end of a discharge.

The red dotted line shows the voltages when power has returned. The lower bar graph indicates those accumulators which have collapsed early and have been discharged to a very low level. These batteries are a risk to the entire system.

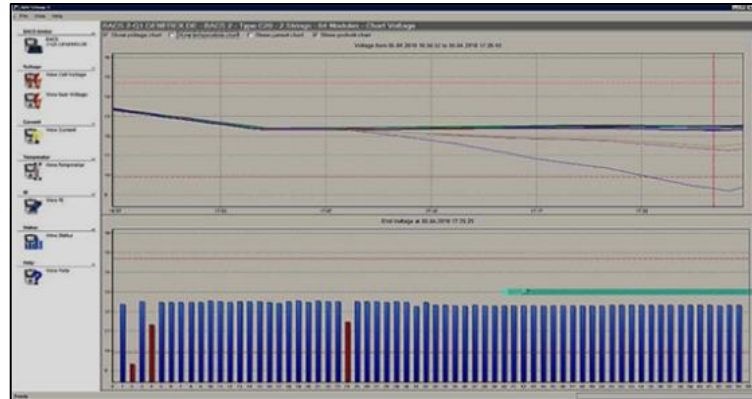

With this important information, it is possible to plan a targeted replacement of damaged batteries – without such detailed information as provided by BACS® all batteries will have had to be replaced, which means a long down time and enormous extra costs associated with otherwise unnecessary replacement units.

● ATEX / Intrinsic safety during regular operation

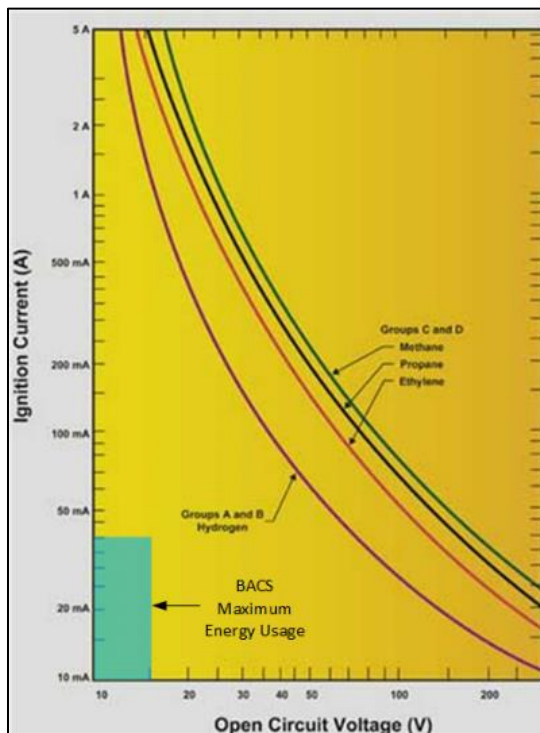

Due to very high safety regulations, the oil and gas industry insists on special protective measures against flying sparks or overheating as soon as IT-related systems have to be operated within the danger zone of potentially highly explosive gases. Since some of these systems must not fail in an emergency, UPS solutions for emergency power supply are often used for protection purposes.

A battery management system in the EX area (explosion-proof area) should therefore - just like the UPS - be able to prove certification according to ATEX in order to be allowed to operate in such environments. **However, such an ATEX certificate is not attainable as soon as a battery is used - because a battery as a hydrogen source may not be used in the EX area at all, since it can generate a spark or even an arc in the event of a short circuit.** I.e. although a battery sensor may be ATEX tested, the validity expires as soon as the sensor is applied to a battery which itself cannot be ATEX safe. This absurdity is not clear to many users and they insist on a certificate for the battery sensors although this actually expires automatically as soon as it is used on batteries.

For this reason, we solve the problem with a different approach: We call our BACS sensor "Intrinsically Safe" -

because the potential for the generation of a spark that can cause gas to ignite cannot be applied to our system. The drawing above left shows the currents and voltages allowed for the respective gas group where an explosion can occur. All units below the respective curve are considered "Intrinsically Safe". BACS is well below this critical range and it is therefore not possible in normal operation to generate an ignition spark which could lead to an explosion.



The picture shows a typical halogen free BACS BC5 measuring cable. The gas-tight sealing of the 1000V fuse is clearly visible. The gas-tight sealing prevents that hydrogen emitted during the charging process can be ignited.

BACS is the only system which has 2 fuses gas-tight installed in the connection cable to the battery. These fuses disconnect the BACS module in case of overvoltage, reverse polarity or overcurrent, and trigger an alarm. These fuses ensure that a BACS module cannot overheat or spark, a unique safety solution in battery management systems making BACS - even without ATEX certification - the safest system on the market.

### **Battery Management versus Battery Monitoring**

A modern uninterruptible power supply (UPS) consists of a charger (rectifier) and a DC / AC converter (inverter). Its functionality depends heavily on the performance of the battery. Even one "failed" battery can negatively affect the reliability of the entire system and trigger a catastrophic event. Therefore, the sooner one knows about a problem, the sooner one can react to it. Therefore, since the late 1970s, stationary battery monitoring systems came into vogue - so-called "Battery **Monitoring** Systems" - BMS for short. Their task was to map the state of health of the battery system. This made it possible to monitor a battery failure remotely - via a network. This brought a certain advantage that one knew about the problems, but could not fight the cause with it. For years this problem was not addressed, only with the appearance of lithium batteries the battery and UPS industry felt compelled to explain why the lead batteries do not reach the design life and are so unreliable and why with lithium batteries a "Battery **Management** System" is used and with lead batteries at most a battery **monitoring** system?

Although a battery monitor provided useful SOH information to indicate faulty batteries, it was never developed to detect or correct the causes of battery failures during and after charging. Only with lithium batteries on the market, battery management for lead/NiCd based batteries was started in 2004 - with resounding success - as can be seen today with BACS!



A given battery string is made up of individual cells or blocs. The rectifier charges the battery string as one collective unit and does not take into account the individual cells or blocs. Each cell or bloc is design with a fixed specification, but each one inherently also has its own unique electrochemical properties. The slightest difference in performance between the cells or blocs will cause a voltage imbalance within the string. **This will result in the overcharge of some cells or blocs, which in turn causes positive grid corrosion, while other cells or blocs become undercharged, causing sulfation.** As industry requirements have led to gradually higher string voltages (in some cases up to 800VDC) the voltage imbalance has become greater—so too has the need to rectify the imbalance!

The voltage imbalance is accelerated when new and old cells or blocs are mixed into the same string. Industry standards suggest that if more than 20-25% of the blocs are required to be replaced in the string, the entire string should be replaced. The reason is that the unbalanced voltages will occur more dramatically when old and new blocs are mixed.

**BACS provides a full battery management system which includes a comprehensive State of Health (SOH) monitor as well as the management features to prevent over and under charging through our Equalization (Balancing) process.** BACS is fully web browser-based, equipping the user with a simple intuitive user interface.

The BACS battery management system uses a passive voltage balancing technique called passive equalization. BACS will measure each individual cell or bloc voltage and calculate the average voltage (target voltage) of the string. In the event that the cell or bloc voltage is above the target voltage (overcharging) BACS will activate a bypass current to provide enough float current to keep the cell or bloc charged while preventing overcharging. The cell or bloc that is below the target voltage (undercharging) is not bypassed and the voltage on that cell or bloc rises naturally toward the target voltage at the same time as the voltage of potentially overcharged cells or blocs is allowed to moderate. **BACS functions by virtue of Kirchhoff's current laws.** The specification of BACS is to balance the individual battery voltages to within 1/100<sup>th</sup> of a volt of the target voltage of the string.

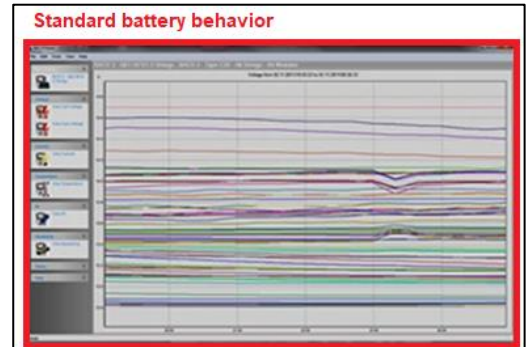

**BACS® VIEWER SCREENSHOT**  
As seen by BACS®, the same 5-year-old system as shown in the previous graphic, this time, after the application of the genuine Equalization (Balancing) process. Within a few hours, this process brings the variance in float voltage to within 1/100<sup>th</sup> of a volt of the level recommended by the manufacturer.



## **BACS WEBMANAGER – A High End CS141-based Device**

- **High-tech Made in Germany / Made in the USA**

The most powerful and flexible UPS management card worldwide is the CS141 – the basis of the BACS WEBMANAGER. Running on an ARM Cortex A8 CPU, 10/100Mbit Auto-sensing Ethernet, 3 serial RS-232 Interfaces, 1 USB Port, AUX port for connecting an external interface Card with 4 dry-contact, external alarms output/input and connecting the BACS modules. Available also as MODBUS RS485 interface at COM2.

- **Security Made in Germany / Made in the USA**

Data protection is very important to GENEREX - the CS141 security concept is therefore designed to comply with both German and American data protection laws. Furthermore, the transparent and intuitive system design can be configured to fit to any local compliance regulations.

- **Graphical interfaces**

The built-in web server is designed for intuitive data monitoring and configuration via the network, to configure the extensive functions of the BACS WEBMANAGER and perform the most powerful statistical analysis found on today's BMS market. The statistical values of all connected devices are displayed graphically - UPS, temperature, humidity, and more. Additionally, the BACS WEBMANAGER provides options to communicate with UNMS (UPS Network Management System) - or any type of other 3<sup>rd</sup> part management software based on SNMP, MODBUS or BACnet. Thanks to the GENEREX API, the BACS WEBMANAGER offers additional interfaces for customers who wish to program custom settings on the device using self-defined scripts.

- **Scheduler**

Use the intuitive task scheduler to plan recurring tasks such as UPS battery tests, AUX output switching, or any other tasks the devices connected to the BACS WEBMANAGER can offer.

- **Data logging**

Measurement values and alarms are logged to the non-volatile storage of the BACS WEBMANAGER. The time synchronization function through NTP ensures that all log entries are precise.

- **Email/SMS**

Integrated email client via SMTP can be configured to relay either all or specific messages. Compatible with SMTP email systems such as MS Exchange/Outlook, Lotus, and many others.



• **Network Services and Security**

The BACS system has full qualified UPS management functionality (our CS141!) on board and supports a vast array of network protocols like SNMP V2/V3, IPv4/IPv6, HTTP/HTTPS, DNS, DHCP, SMTP, NTP, SFTP, UPSTCP (UNMS), MODBUS over IP, MODBUS/PROFIBUS over RS232 or RS485, BACnet and GENEREX proprietary network protocols like UPSTCP (for UNMS) and RCCMD for network computer shutdown management.

The BACS WEBMANAGER provides manifold security features to ensure a maximum of network security. The BACS WEBMANAGER uses industrial standards to provide HTTPS and SSL encrypted communication with user created certificates. It can be configured to deny outdated or invalid certificates and it provides encrypted SNMP communication (V3), but also less secured systems are supported. Advanced password security and hard-coded user management provides configuration menus according to user level. As a special feature, the BACS WEBMANAGER provides tools to assist network administrators during network security auditing of a network segment.

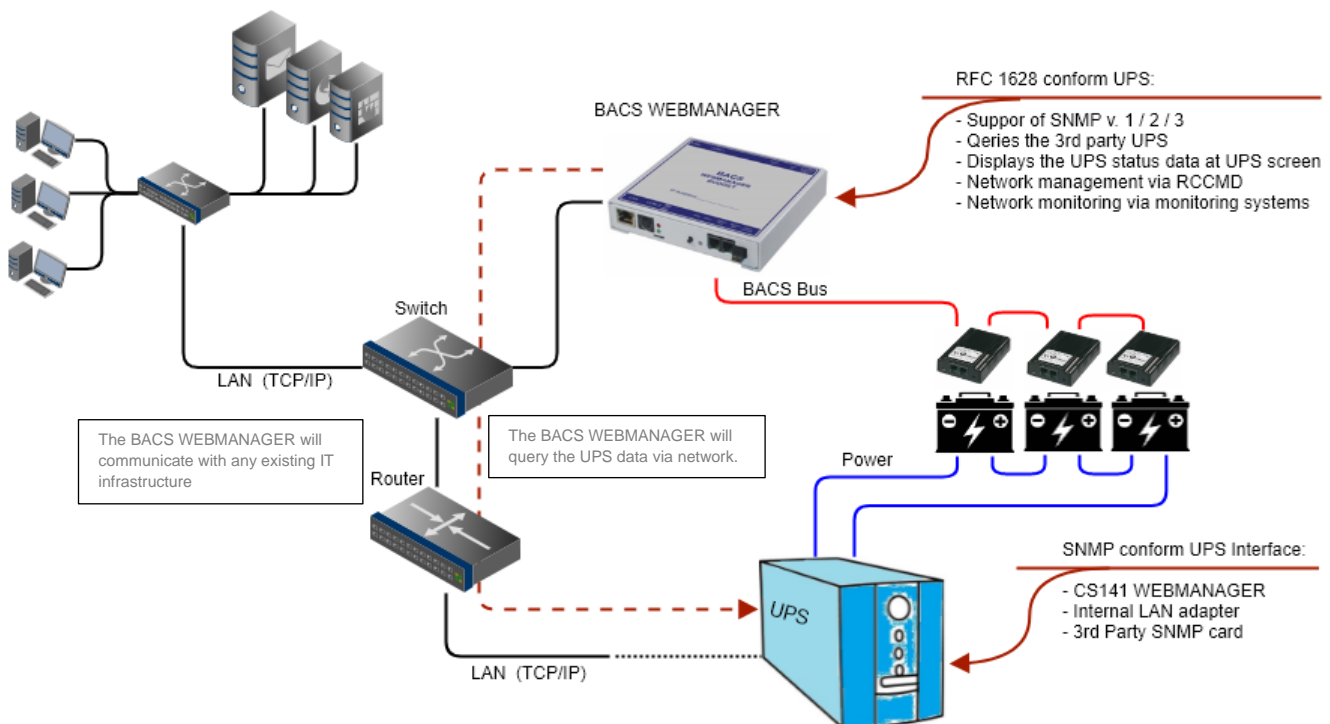



**FUNCTION OVERVIEW: BACS WEBMANAGER**

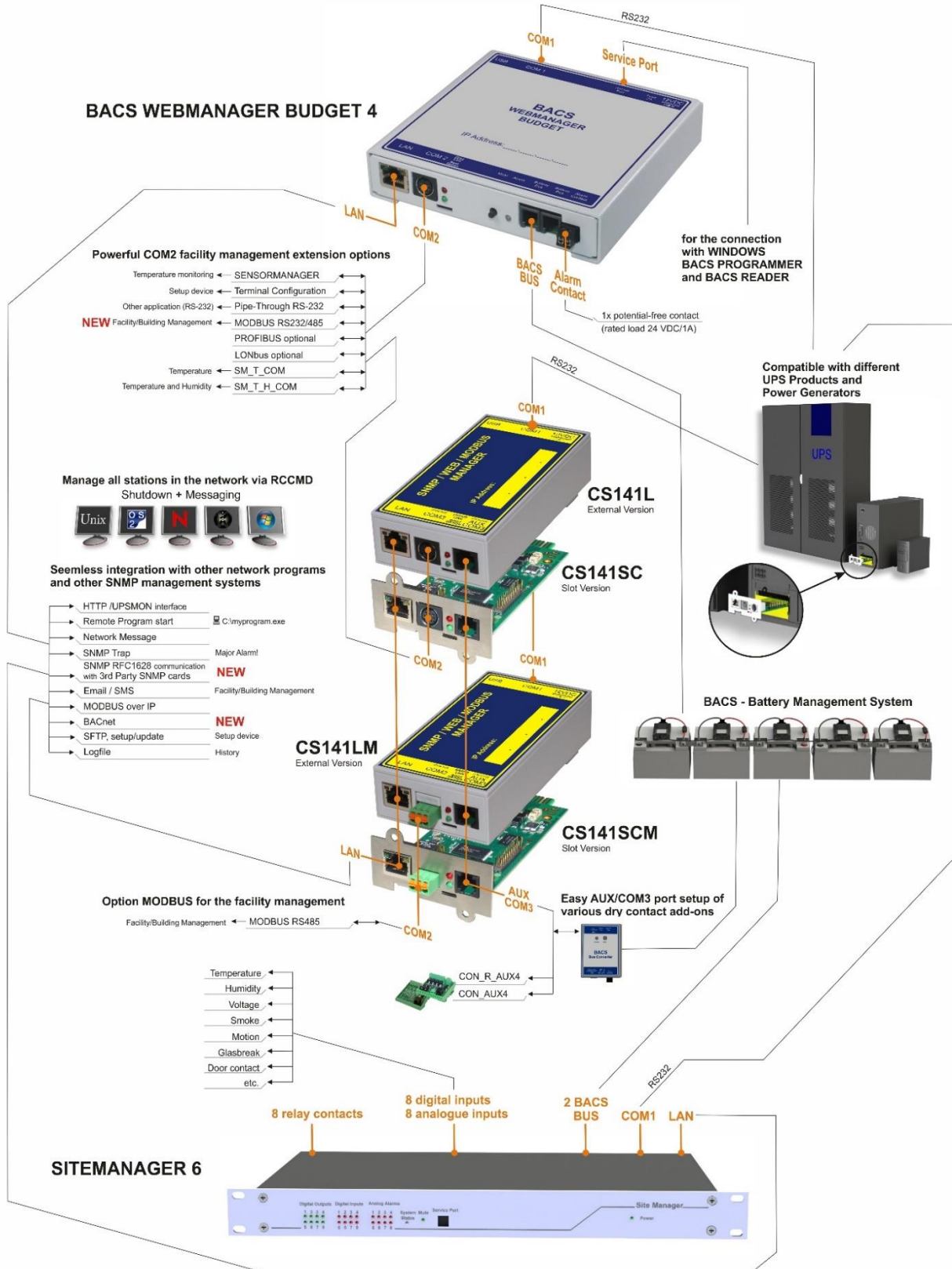



**BACS® System Components**

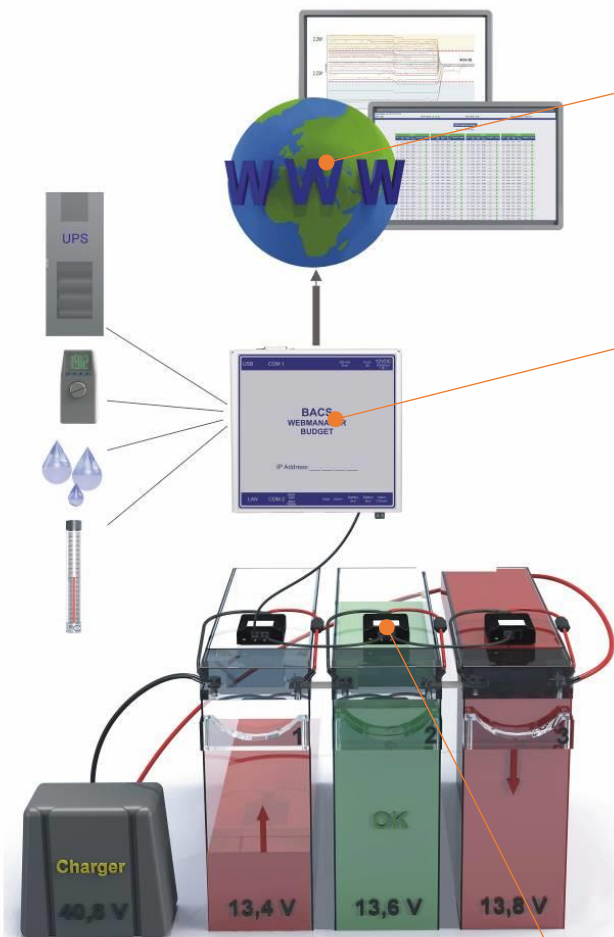

BACS WEBMANAGER balances the voltages on the batteries 1 and 3

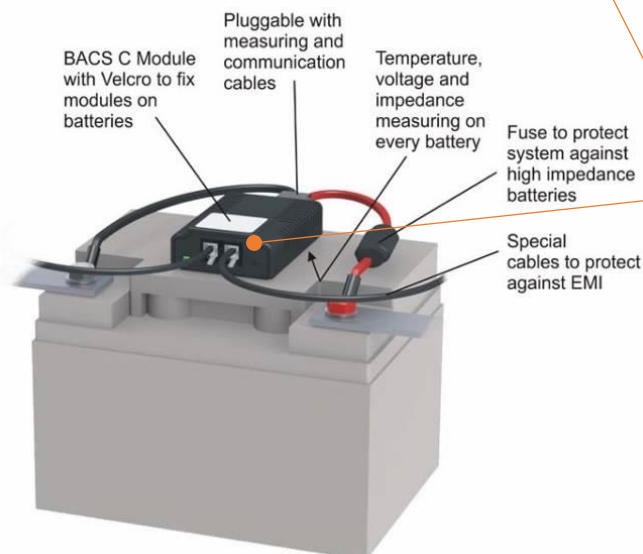

**BACS® VIEWER**

Network monitoring software for professional deep battery analysis, statistical data evaluation and advanced maintenance management.

**BACS® WEB-MANAGER in 5 Versions**

3 external versions incl. a Rack model plus 2 UPS slot versions

Management of up to 512 BACS® C modules in up to 16 parallel strings.

Includes a fully qualified UPS-SNMP & MODBUS and BACnet manager at COM 1 and over Network for the monitoring of a UPS/inverter/rectifier/generators or other devices with a serial interface or network SNMP interface.

COM2 for optional environmental sensors (e.g. temperature, humidity, current, acid fill level, etc.).

One programmable alarm relay output, one alarm-LED, one alarm buzzer, mute button.

Integrated web server for status display configuration of all alarm thresholds (battery impedance, voltage, temperature, UPS alarms, environmental alarms, etc. network messaging system (email, SMS, SNMP, RCCMD, MODBUS, BACnet and (optional) PROFIBUS and LONBUS.

Data logger for all measuring data, current sensors (optional) for charge and discharge current measuring.

Compatible to UNMS monitoring software

**BACS® C MODULE & CABLE**

Diagram of a BACS® module installation:

A calibrated measuring cable with two high-voltage fuses connected to the positive and the negative Battery poles uses a 4-string wire for measuring the individual battery data.

The BACS® module measures through an integrated sensor the surface temperature of the accumulator, the voltage and the impedance.

The BACS® module is available in 5 different types: 16-volt, 12-volt, 6-volt, 4-volt, 2 volts for Lead/Acid, NiCad, NiMH and Lithium-Ion batteries.

**BACS® System Components**

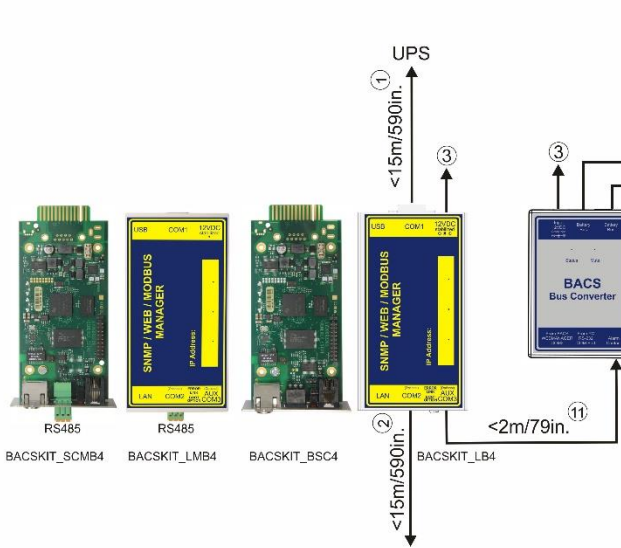

1. Max. distance 15m/590in. to COM 1 RS232 device (UPS, Genset, Transfer Switch, Charger or other battery-powered device) managed by BACS
2. Max. distance 15m/590in. to COM 2 RS232 for Environmental sensors (SM\_T\_COM, SM\_TH\_COM) or 3rd Party Sensors with SENSORMANAGER BACSKIT\_LB4
3. Power Supply 12V/2A (UPS protected). For more than 300 BACS Modules a 3A Power Supply is required
4. Max. distance from BACS Bus Converter to BACS SPLITTING BOX should not exceed 10m/395in.
5. Distance between BACS SPLITTING BOX in daisy chain should be <2m/79in. – or shorten the total length of bus from 50m/1970in. accordingly. (Eg. reduce to 40m/1575in. to gain 10m/395in. for the distance between the 2nd BACS SPLITTING BOX)
6. Total Length of a BACS bus must not exceed 60m/2360in. and 50 BACS Modules, measured from the BACS WEBMANAGER. 6 + 9
7. BACS bus cable length between BACS modules for the interconnection. In this example 40cm/16in. Shorter interconnecting cables would increase the distance of 50m/1970in. accordingly, longer interconnecting cables would shorten the distance of 50m/1970in.
8. Max. number of BACS Modules is 512.
9. Max. distance from BACS Bus Converter to BACS CURRENT SENSORS should not exceed 10m/395in.
10. Max. distance from BACS Bus Converter to BACS CURRENT SENSORS (1-16) and BACS GX\_R\_AUX Dry-contacts (1-4) should not exceed 50m/1970in. in total.
11. Max. distance from CS141 to BACS Bus Converter should not exceed 2m/79in.

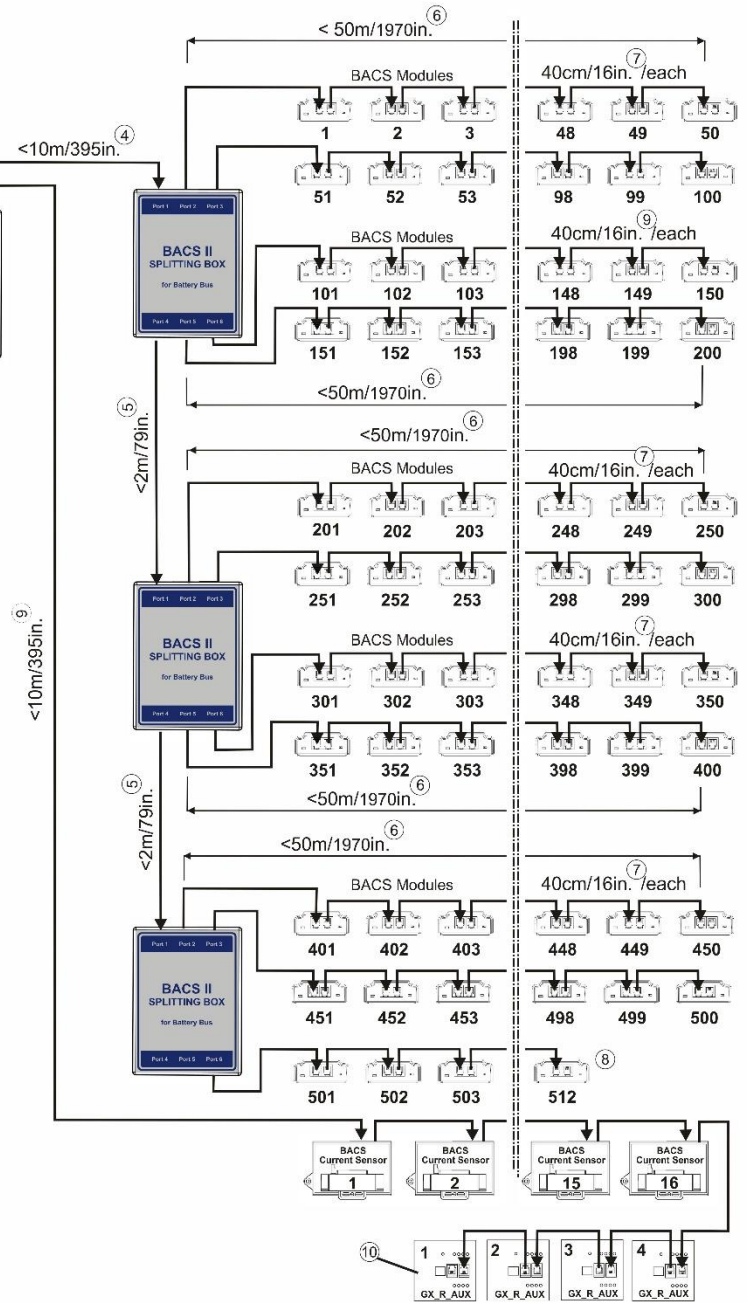





BACS® System Components

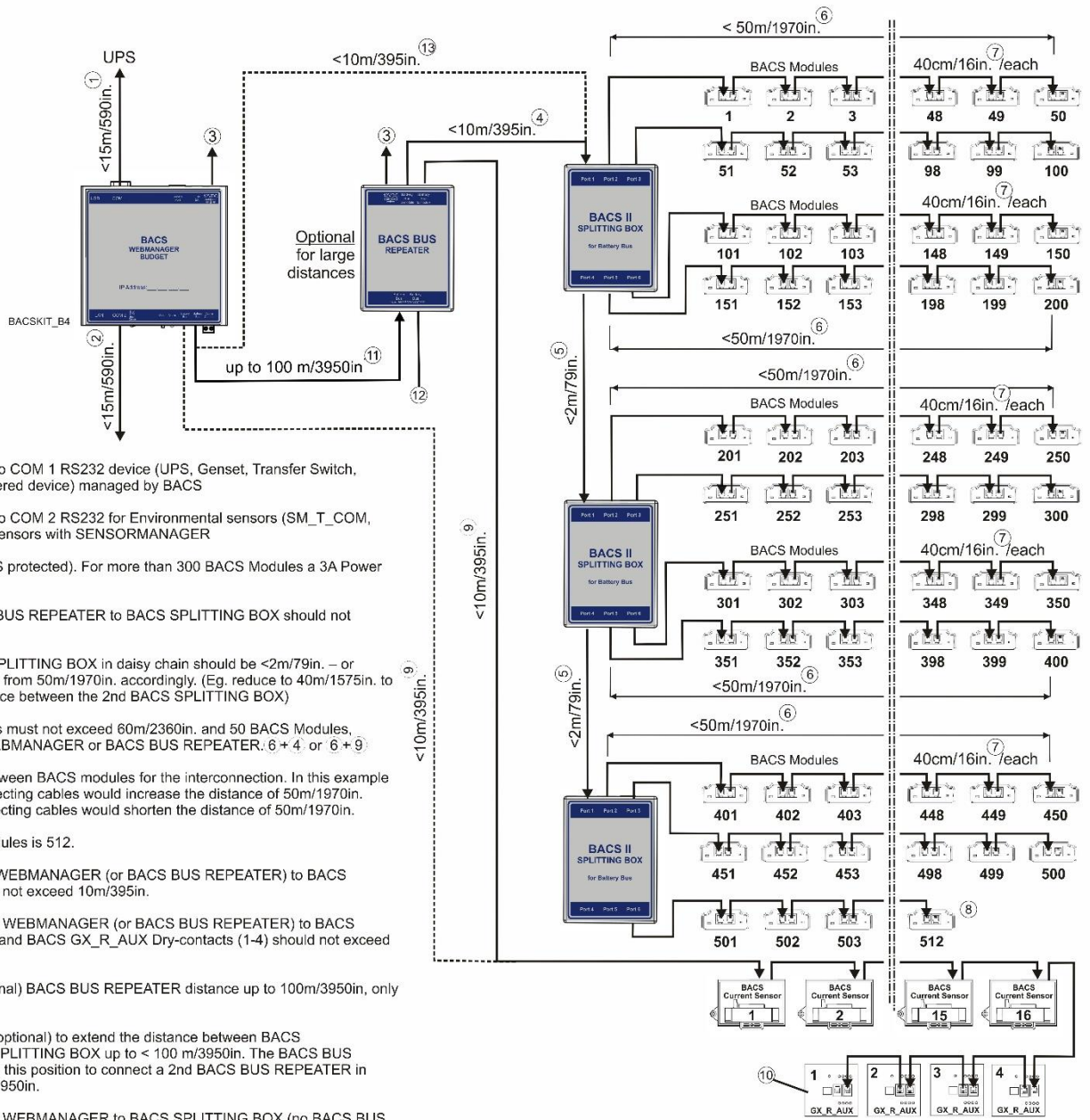

1. Max. distance 15m/590in. to COM 1 RS232 device (UPS, Genset, Transfer Switch, Charger or other battery-powered device) managed by BACS
2. Max. distance 15m/590in. to COM 2 RS232 for Environmental sensors (SM\_T\_COM, SM\_TH\_COM) or 3rd Party Sensors with SENSORMANAGER
3. Power Supply 12V/2A (UPS protected). For more than 300 BACS Modules a 3A Power Supply is required
4. Max. distance from BACS BUS REPEATER to BACS SPLITTING BOX should not exceed 10m/395in.
5. Distance between BACS SPLITTING BOX in daisy chain should be <math>< 2\text{m}/79\text{in.}</math> – or shorten the total length of bus from 50m/1970in. accordingly. (Eg. reduce to 40m/1575in. to gain 10m/395in. for the distance between the 2nd BACS SPLITTING BOX)
6. Total Length of a BACS bus must not exceed 60m/2360in. and 50 BACS Modules, measured from the BACS WEBMANAGER or BACS BUS REPEATER:  $6 + 4$  or  $6 + 9$
7. BACS bus cable length between BACS modules for the interconnection. In this example 40cm/16in. Shorter interconnecting cables would increase the distance of 50m/1970in. accordingly, longer interconnecting cables would shorten the distance of 50m/1970in.
8. Max. number of BACS Modules is 512.
9. Max. distance from BACS WEBMANAGER (or BACS BUS REPEATER) to BACS CURRENT SENSORS should not exceed 10m/395in.
10. Max. distance from BACS WEBMANAGER (or BACS BUS REPEATER) to BACS CURRENT SENSORS (1-16) and BACS GX\_R\_AUX Dry-contacts (1-4) should not exceed 50m/1970in. in total.
11. BACS bus port with (optional) BACS BUS REPEATER distance up to 100m/3950in, only 1 bus cable required.
12. BACS BUS REPEATER (optional) to extend the distance between BACS WEBMANAGER and BACS SPLITTING BOX up to <math>< 100\text{m}/3950\text{in.}</math>. The BACS BUS REPEATER has a 2nd Port at this position to connect a 2nd BACS BUS REPEATER in series to gain another 100m/3950in.
13. Max. distance from BACS WEBMANAGER to BACS SPLITTING BOX (no BACS BUS REPEATER between) should not exceed 10m/395in.



**BACS® System Components**

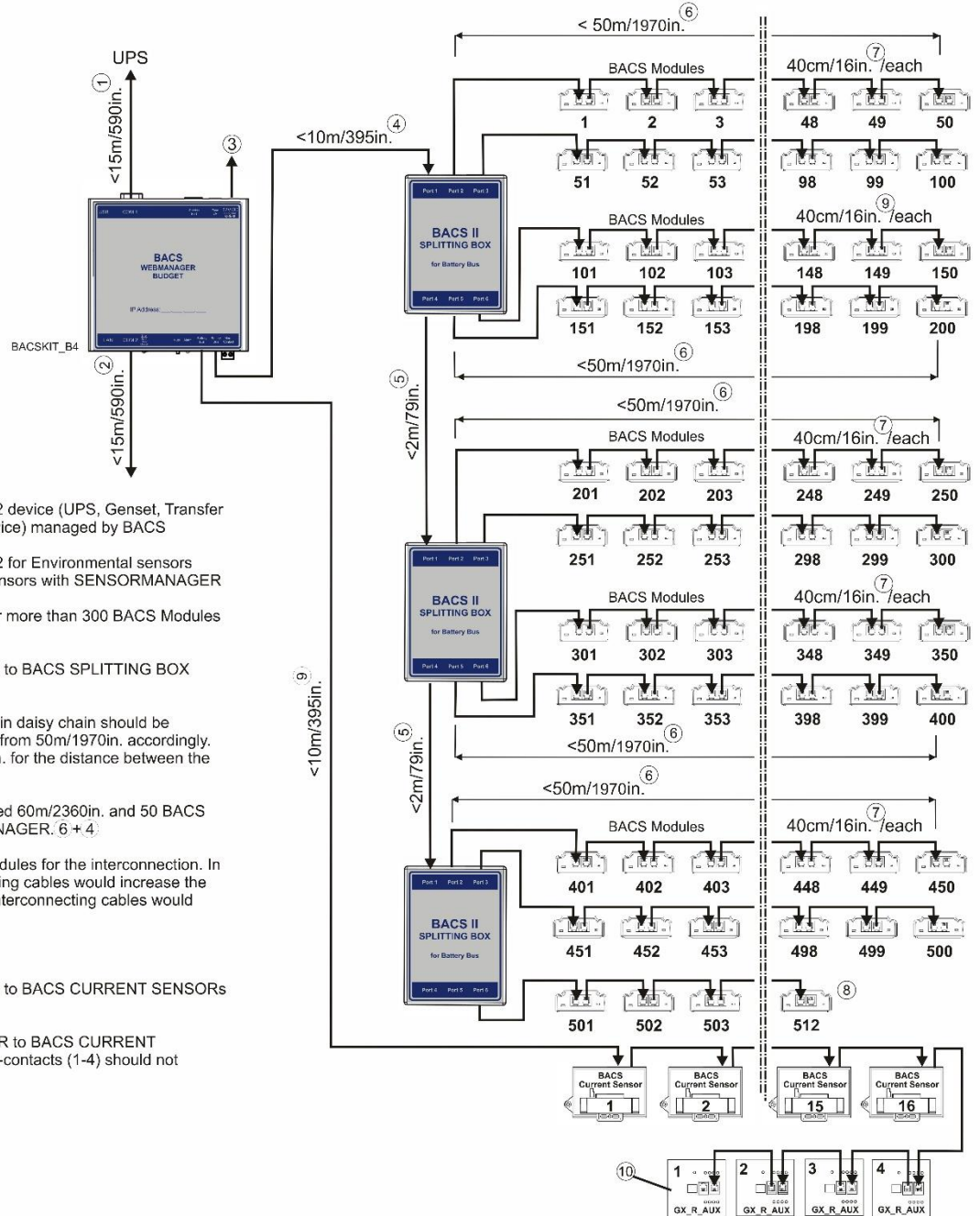

1. Max. distance 15m/590in. to COM 1 RS232 device (UPS, Genset, Transfer Switch, Charger or other battery-powered device) managed by BACS
2. Max. distance 15m/590in. to COM 2 RS232 for Environmental sensors (SM\_T\_COM, SM\_TH\_COM) or 3rd Party Sensors with SENSORMANAGER
3. Power Supply 12V/2A (UPS protected). For more than 300 BACS Modules a 3A Power Supply is required
4. Max. distance from BACS WEBMANAGER to BACS SPLITTING BOX should not exceed 10m/395in.
5. Distance between BACS SPLITTING BOX in daisy chain should be <2m/79in. – or shorten the total length of bus from 50m/1970in. accordingly. (Eg. reduce to 40m/1575in. to gain 10m/395in. for the distance between the 2nd BACS SPLITTING BOX)
6. Total Length of a BACS bus must not exceed 60m/2360in. and 50 BACS Modules, measured from the BACS WEBMANAGER. 6 + 4
7. BACS bus cable length between BACS modules for the interconnection. In this example 40cm/16in. Shorter interconnecting cables would increase the distance of 50m/1970in. accordingly, longer interconnecting cables would shorten the distance of 50m/1970in.
8. Max. number of BACS Modules is 512.
9. Max. distance from BACS WEBMANAGER to BACS CURRENT SENSORS should not exceed 10m/395in.
10. Max. distance from BACS WEBMANAGER to BACS CURRENT SENSORS (1-16) and BACS GX\_R\_AUX Dry-contacts (1-4) should not exceed 50m/1970in. in total.





**Technical data**

**General technical data: CS141 / BACS HW161 Webmanager Product family**

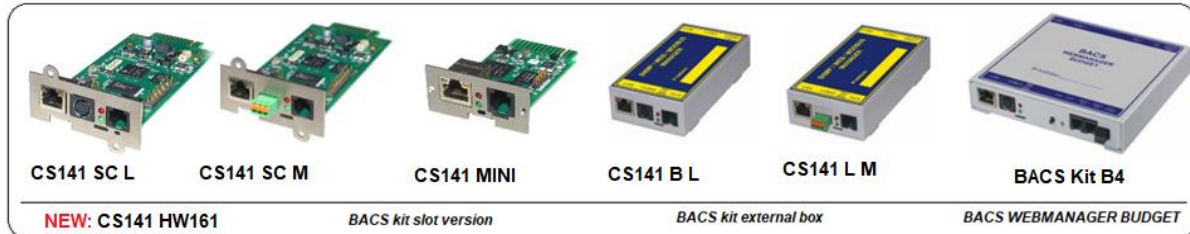

<b>CS141 PRODUCT SERIES GENERAL OPERATING DATA</b>	
Processor and memory	ARM Cortex A8 800MHz CPU, 8GB storage for battery history.
Operating condition	Temperature 0 - 60°C, max. humidity 0 - 90%, non-condensing
MTBF (calculated)	849192 hours; 96,9 years
corresponds to RAL 7035 Power consumption	At 12V default power supply consumption approx. 150mA. Note: At BACS a CONVERTER is included.
MTBF (calculated)	849192 hours; 96,9 years
maximierenDisplay	2x LED (Manager status, UPS/device alarm)
External BACS kit CS141 housing	ABS, corresponds to RAL 7035 (light grey) CE, UL 94/NEMKO certified flame retardant
SLOT BACS kit CS141 housing	Slot card "SC format" for UPS devices witch compatible slots UL- Certification
BACS Webmanager Budget housing	Aluminum, RAL 7035 (light gray) UL/NEMKO certificated – or – ABS 94/NEMKO certified flame retardant with integrated DIN Rail
Number of possible BACS modules	The Standard Power supply (2000 mA) grants power for up to 360 BACS C modules. For up to 512 modules and sensors, ask for larger power supply.
Operation altitude range	0m – 4000m
Operating maintenance	Removal of dust and dirt in regular terms is required, beside this, the BACS WEBMANAGER, measuring cables and the BACS modules do not need any maintenance work. There is no internal battery used that need maintenance or replacement.
<b>BACS GENERAL STORAGE DATA</b>	
Temperature range	-55°C – 70°C
Humidity range	0% -90% in non condensing environments
Storage altitude range	0m – 4000m
Particular additional information	Open storage in heavily sooty or dusky storage conditions or environments with sediment deposits can have a negative effect. Acidic or similar aggressive atmospheric environmental conditions may also affect long-term storage
Storage Maintenance	The BACS WEBMANAGER, measuring cables and the BACS modules do not need any maintenance work during storage. There is no internal battery used that need maintenance or replacement

**BACS kit product bundle differences to general data:**

	<p><b>BACS® WEBMANAGER BUDGET SC (slot version)</b> Order No. BACSKIT_BSC4</p>
	<p><b>Interfaces</b></p> <p>3x RS-232 interfaces, (COM1= UPS/power device, COM2 =Multipurpose, COM3=BACS battery bus) 1x RJ12 for battery bus converter 1x RJ45, 10/100Mbit Ethernet</p>



	<b>BACS® WEBMANAGER BUDGET SC MINI (Mini Slot Version)</b> Order No. <b>BACSKIT_BSC4</b>	
	Interfaces	1x RJ12 Multiport for accessories and battery bus converter 1x Spitting Port cable for simultaneous use  1x RJ45, 10/100/ 1000Mbit Ethernet

	<b>BACS® WEBMANAGER BUDGET L</b> Order No. BACSKIT_LB4	
	Interfaces	3x RS-232 interfaces, (COM1= UPS/power device, COM2 =Multipurpose, COM3=BACS battery bus) 1x RJ12 for battery bus converter 1x RJ45, 10/100/ 1000Mbit Ethernet



	<b>BACS® WEBMANAGER BUDGET SCM RS485 (slot version)</b> Order No. BACSKIT_SCMB4	
	Interfaces	2x RS-232 interfaces, (COM1= UPS/power device, COM3=BACS battery bus), 1 * RS485 = COM2 1x RJ12 for battery bus converter 1x RJ45, 10/100/ 1000Mbit Ethernet



	<b>BACS® WEBMANAGER BUDGET LM RS485</b> Order No. BACSKIT_LMB4	
	Interfaces	2x RS-232 interfaces, (COM1= UPS/power device, COM3=BACS battery bus), 1x RS485 1x RJ12 for battery bus converter 1x RJ45, 10/100/ 1000Mbit Ethernet

**BACS WEBMANAGER BUDGET differences to general data:**

	<b>BACS® WEBMANAGER BUDGET - 12V</b> Order No. BACSKIT_B4	
	Interfaces	3x RS-232 interfaces, (COM1= UPS/power device, COM2 =Multipurpose, service port for Windows BACS READER and PROGRAMMER software) USB 2x battery bus converter outputs internal 1x RJ45, 10/100Mbit Ethernet 1x potential-free contact (2 pole screw wire size 1,0 mm <sup>2</sup> , rated load 24 VDC /1A)
Dimension	130 x125 x 30mm = 5,12 x 4,92 x 1,18 in. (W x L x H)	
Weight	Aluminium 360g / ABS housing 238g	



	<p><b>BACS® WEBMANAGER BUDGET - 18V-72V</b> Order No. BACSKIT_B4</p>	
	<p>Interfaces</p> <p>Dimension Weight</p> <p>Input Output Notes</p>	<p>3x RS-232 interfaces, (COM1= UPS/power device, COM2 =Multipurpose, service port for Windows BACS READER and PROGRAMMER software) USB 2x battery bus converter outputs internal 1x RJ45, 10/100Mbit Ethernet 1x potential-free contact (2 pole screw wire size 1,0 mm<sup>2</sup>, rated load 24 VDC /1A 130 x125 x 30mm = 5,12 x 4,92 x 1,18 in. (W x L x H) Aluminium 360g / ABS housing 238g</p> <p><b>Technical data: TRACOPOWER TCL 024-112DC</b></p> <p>18V – 72V DC 12V 2000mA DC stabilized up to 390 BACS Modules Input safeguarding fuse (recommended circuit breaker 6-16A / characteristic C) is not included.</p>

	<p><b>BACS® WEBMANAGER BUDGET - 90V-375V</b> Order No. BACSKIT_B4_375</p>	
	<p>Interfaces</p> <p>Dimension Weight</p> <p>Number of modules</p> <p>Input Output Notes</p>	<p>3x RS-232 interfaces, (COM1= UPS/power device, COM2 =Multipurpose, service port for Windows BACS READER and PROGRAMMER software) USB 2x battery bus converter outputs internal 1x RJ45, 10/100Mbit Ethernet 1x potential-free contact (2 pole screw wire size 1,0 mm<sup>2</sup>, rated load 24 VDC /1A 130 x125 x 30mm = 5,12 x 4,92 x 1,18 in. (W x L x H) Aluminium 360g / ABS housing 238g The power supply provides 1960mA are for up to 392 BACS C modules and other BACS components.</p> <p><b>Technical data: TRACOPOWER TPCL 030-112DC</b></p> <p>90 – 375V VDC or 85 - 264VAC 12V 2200mA DC stabilized up to 390 BACS Modules Input safeguarding fuse (recommended circuit breaker 6-16A / characteristic C) is not included.</p>

**NEW:** In 2022, also available: The BACS Kit “LC” (Low Cost)



- **Special Design for smaller systems with up to 6 KVA**
  - o Prepare your UPS / SOLAR system for the next generation battery management
  - o Simply Start managing your batteries how it ever should be done
  - o No hidden “pay-per use” for new functions.
  
- **Benefit from all BACS features for up to 24 batteries**
  - o Use all professional BACS features
  - o Benefit from the advanced technical support
  - o Use all professional modules available for BACS



**- Scalable by design:**

- No new basic hardware required
- Use the upgrade capabilities to expand your system as needed
- Just enter a serial key unlock the full UPS list

**As “LC” available products:**



Order No	Product is identical to	Limitation overview
BACS WEBMANAGER B4LC	BACSKit B4	- Up to 24 batteries - Up to 6 KVA Ups
BACS WEBMANAGER CS141 BSC4LC	BACSKIT_BSC4	
BACS WEBMANAGER CS141 BL4LC	BACSKIT_BL4	
BACS WEBMANAGER CS141SCMB4LC	BACSKIT_SCMB4	
BACS WEBMANAGER CS141SCMB4LC with RS485	BACSKIT_SCMB4 / RS485	
BACS WEBMANAGER CS141LMB4LC with RS485	BACSKIT_LMB4 / RS485	
<b>LICENCE Upgrades</b>		
BACSCSLCUPG	<i>License: Converts all LC Editions into a fully qualified BACS system</i>	- Unlocks all limitations - Software License key

**BACS All-In-One - Solution:**

<b>SITEMANAGER 6</b> Order No. SITEMAN_6	
Processor and memory	ARM Cortex A8 800MHz CPU, 30 MB storage for battery history Non-volatile memory for alarm notification after power loss
Power consumption	40 watts max.
Interface	RS-485 interface for other devices / Adapter for RS232 support
Inputs	8 digital inputs (opened / closed configurable) 8 analog inputs (0 - 10V, 4 - 20mA, 0 - 20mA configurable via jumpers) 2 x RJ10 for BACS battery bus
Outputs	8 relay outputs (changer, max. 230V/ 4A AC/DC)
Network	10/ 100/ 1000Mbit LAN
Supported protocols	Email, HTTP/HTTps, SNMP, SNTP, MODBUS Over IP, BACnet, UPSTCP, DHCP, DNS, sFTP
Front Display	LED alarm display, LED operating status display
Dimensions	483 x 162 x 44mm, (483 x 212 x 44mm incl. SM_LOOM) 19,00 x 6,38 x 1,73in, (19,02 x 8,35 x 1,73in incl. SM_LOOM)
Weight	2262 g
Operating condition	Temperature 0 - 70°C, max. humidity 20 - 95%, not condensing
Network management	UNMS II Network Management software
Network Adapter	Optional PROFIBUS, LONBUS adapter
Additional sensors	Smoke/fire alarms, motion detectors, door contacts etc., connection of any other alarm contact indicator, which output signal is between 0 - 10V,4 -20mA or rather 0 - 20mA (configurable via jumpers)
Actuators	flash light, alarm buzzer, relay-switches, external switches, etc.





**BACS Accessories**



	<p><b>BACS® BUS CONVERTER 5</b></p>	
<p>Order No. BACS_BUS_CONV_V</p>		
<p>Construction</p>	<p>Conversion and galvanic separation of the BACS battery bus to the BACS WEBMANAGER BUDGET plus real time clock (RTC) timer for the BACS WEBMANAGER.</p>	
<p>Power Supply</p>	<p>Stabilized external 12V/2000mA</p>	
<p>Number of modules</p>	<p>Standard Power supply grants power for up to 360 BACS C modules. For up to 512 Modules and sensors, a larger power supply is available.</p>	
<p>Interface</p>	<p>2x RJ10 for BACS battery bus                  1xRJ12 for COM3 BACS WEBMANAGER BUDGET                  1xMiniDin8/RS232 interface for serial connection to workstation.                  1x2,1mm DC connector socket for power supply via external power supply                  1x potential-free contact                  (2 pole screw terminals for 1,0 mm<sup>2</sup> /24 VDC /1A)</p>	
<p>Display</p>	<p>Optical display (LED)</p>	
<p>Alarm</p>	<p>Internal alarm buzzer with acknowledge button</p>	
<p>Housing</p>	<p>Polystyrene</p>	
<p>Optional parts</p>	<p>Optional: Adapter from mini-8 to RS232 for the BACS Reader, with junction cable mini-8 1.5m</p>	
<p>Dimension</p>	<p>91,5 x 67 x 25 (W x H x D)</p>	
<p>Weight</p>	<p>120g</p>	
	<p><b>BACS® SPLITTING BOX</b></p>	
<p>Order No. BCII_SPLITT</p>		
<p>Construction</p>	<p>Passive splitter for BACS communication cables, designed to optimize the overall cable lengths and to create an optical pleasant wiring. In addition to the extension of the 2 BACS bus inputs of the BACS CONVERTER.</p>	
<p>Power supply</p>	<p>Passive element, no additional power supply required</p>	
<p>Interfaces</p>	<p>5* RJ10 for BACS bus cables                  1x RJ10 input connector for BACS bus data input</p>	
<p>Housing</p>	<p>Polystyrene</p>	
<p>Dimension</p>	<p>91,5 x 67 x 25 (B x H x T)</p>	
<p>Weight</p>	<p>90g</p>	
<p><b>BACS® DC current sensor</b>  <b>50/200/400/1000/2000 Ampere</b></p>		
<p>Ord. No: BACS_CSH50, BACS_CSH200, BACS_CSH400, BACS_CSH1000, BACS_CSH2000</p>		<p>Construction</p>
<p>DC current sensor for measuring battery string discharge and charging process +/-50A, +/-200A, +/-400A, +/-1000A, +/-2000A DC Current transducer diameter hole: 21mm [0,82in] (BACS_CSH50) /40 mm [1.57in]</p>		<p>Power supply</p>
<p>Intern powered by BACS bus</p>		<p>Power consumption</p>
<p>60mA</p>		<p>Interfaces</p>
<p>2x RJ10 for BACS bus cable, pluggable system</p>		<p>Housing</p>
<p>DIN Rail</p>		<p>Dimension (LxWxH)</p>
<p>110 x 82 x 125 mm = 4,33 x 3,22 x 4,92 in. (LxWxH)</p>		<p>Weight</p>
<p>420g</p>		





 <b>BACS® bus interface GX_R_AUX</b> Order No. GX_R_AUX		
	<b>Description</b>	Input alarms and Output relay management. A typical application is the control of a battery breaker in case of "thermal runaway" alarm in the battery system. Applies to US Norm International Fire Code IFC 608.3 for isolating UPS batteries in case of a thermal runaway. In case of a high battery temperature and increasing voltages during float charge, the GX_R_AUX may open the battery breaker to stop a further increase of the temperatures in the batteries. Individual programming of the relays through web interface.
	<b>Inputs</b>	4 digital inputs (configurable NO/NC)
	<b>Outputs</b>	4 Relay potential-free outputs (NO/NC) / 50VAC – 2A, 30VDC – 1A
	<b>Power supply</b>	Powered by BACS bus, no external power supply
	<b>Power consumption</b>	170mA
	<b>Housing</b>	Polyamide, pluggable system DIN rail
	<b>Dimension</b>	75 x 75 x 45mm = 2,95 x 2,95 x 1,77 in. (LxWxH)
	<b>Weight</b>	170g
<b>BACS® external temperature sensor</b> Order No. BACS_TS1L23, BACS_TS1L90		
	<b>Construction</b>	External temperature sensor for BACS REV 3 (Optional). If this sensor is attached, the internal temperature sensor of the BACS module will be automatically switched off.
	<b>Cable length</b>	23cm (9.06in) / 88cm (34.65in) cable
	<b>Delivery content</b>	Sensor only, has to be attached to the BACS C module by a qualified BACS service engineer
	<b>Housing</b>	UL certified material, voltage proofed up to 1000V
	<b>Measuring range precision</b>	-10°C - +90°C, +/- 1°C
<b>Dimension</b>	2cm x 1.5cm x 1cm) (0.87 x 0.58 x 0.37 Inch “)	





**Modules and cables**

 <b>BACS® modules Generation 3</b>		
	<b>Construction</b>	Measuring modules with passive balancing/equalization
	<b>current consumption from battery</b>	BACS is a registered and protected trade mark normal operation: 15 - 20mA (C20, C23, C30) 35 - 40mA (C40, C41) "Sleep Mode": < 1mA
	<b>Measuring precision</b>	Internal resistance: < 10 % at C40, < 5% at C20/30 Voltage: < 0,5 % Temperature: < 15 %
	<b>Interfaces</b>	2x RJ10 for BACS battery bus Internal RS232 bus interface 1x button for the addressing Temperature sensor -35 bis + 85 °C Optical display LED (alarms red/green, mode red/green)
	<b>Housing</b>	ABS housing (UL certified, flame retardant, cooling fins)
	<b>Dimensions, weight</b>	55 x 80 x 24 mm = 2,17 x 3,15 x 0,94 in. (B x H x T), 45g
	<b>Operating condition</b>	Temperature 0 - 60°C, max. humidity 90%, not condensing
	<b>Int. protection rating</b>	IP 42 coated against dust and condensate
	<b>High voltages security tested</b>	Protection against high ohmic batteries fault voltages up to 150 Volt /per module (fuse opens). At higher voltages the fuse opens, but BACS module is damaged. All REV 3.1 modules are designed for fault voltages up to 1000 Volt
	<b>MTBF (calculated)</b>	87.600 hours (10 years)







 	<b>Module BACS® C23</b> Order No. BACSC23 REV 3 module for 16Volt 7-600Ah lead, NiCad, NiMH, Lithium batteries	
	Voltage range RI range Equalization power	9.7V – 21V 0.5-60mOhm 0.12 A
 	<b>Module BACS® C20</b> Order No. BACSC20 REV 3 module for 12Volt 7-600Ah lead, NiCad, NiMH, Lithium batteries (UL certified)	
	Voltage range RI range Equalization power	9.7V – 17V 0.5-60mOhm 0.15 A
 	<b>Module BACS® C30</b> Order No. BACSC30 REV 3 module for 6Volt 7-900Ah lead, NiCad, NiMH, Lithium batteries	
	Measuring value RI range Equalization power	4.8V – 8.0V 0.5-60mOhm 0.3 A
 	<b>Module BACS® C41</b> Order No. BACSC41 REV 3 module for 4Volt 7-900Ah lead, NiCad, NiMH, Lithium batteries (UL certified) (Auld)	
	Measuring value RI range Equalization power	2.4V – 5.0V 0.5-30mOhm 0.3 A
 	<b>Module BACS® C40</b> Order No. BACSC40 REV 3 module for 2Volt 7-9000Ah lead, NiCad, NiMH, Lithium batteries (UL certified)	
	Measuring value RI range Equalization power	1.25V – 3.2V 0.02-6mOhm 0.9 A (at 2.27V)

**BACS Cables**



 	<b>BACS® measuring cables</b> Order No. BC4B-xxxxx	
	Description  cable cross section nominal voltage U <sub>0</sub> /U fuses temperature range	Measuring cables made of UL certified material for BACS sensors type C40 REV 3. Unique high voltage precision fuses for system protection and precise measurements  2x1,50mm <sup>2</sup> 300V/500V 1000V/10A und 1000V/1A -25°C – 70°C
 	<b>BACS® measuring cables</b> Order No. BC4B-xxxxxH	
	Description  cable cross section nominal voltage U <sub>0</sub> /U fuses temperature range Cable coating	Measuring cables made of halogen free, extremely fire resistant and oil resistant material, for BACS sensors type C40 REV 3. Unique high voltage precision fuses for system protection and precise measurements.  2x1,50mm <sup>2</sup> 300V/500V 1000V/10A und 1000V/1A -15°C – 70°C halogen free in accordance with VDE0281 part 14
	<b>BACS® measuring cables</b> Order No. BC5-xxxxx	



 <p>Description</p> <p>cable cross section nominal voltage U<sub>0</sub>/U fuses temperature range</p>	<p>Measuring cables made of UL certified material for BACS sensors type C20 REV. 3, C23 REV. 3, C30 REV. 3 and C41 Rev. 3. Unique high voltage precision fuses for system protection and precise measurements</p> <p>2x0,75mm 300V/300V 1000V/2A und 1000V/500mA -25°C – 70°C</p>
<p><b>BACS® measuring cables</b> Order No. BC5-xxxxxH</p>	
 <p>Description</p> <p>cable cross section nominal voltage U<sub>0</sub>/U fuses temperature range Cable coating</p>	<p>Measuring cables made of halogen free, extremely fire resistant and oil resistant material, for BACS sensors type C20 REV. 3, C23 REV. 3, C30 REV. 3 and C41 Rev. 3. Unique high voltage precision fuses for system protection and precise measurements</p> <p>2x0,75mm<sup>2</sup> 300V/300V 1000V/2A und 1000V/500mA -15°C – 70°C halogen free in accordance with VDE0281 part 14</p>
 <p><b>Bus</b></p>	<p><b>BACS® bus cables</b> Order No. B4BCRJx</p>
 <p>Description Cable coating Contacts Cable length</p>	<p>High quality communication BACS bus communication cable halogen free in accordance with VDE0281 part 14 twisted pair RJ10 Various lengths available. See latest BACS price list for details</p>

**BACS® CONTROL CABINETS: Technical data and dimensions**

Control cabinet for BACS® systems. Plug-play, with AC input plug (Euro) ready to install. With optical and audible display on the outside door, protection class IP 54 with application of included bottom plate.

	<p><b>BACS® CONTROL CABINET Type 1</b> Order No. BACS_CC1</p>	
	<p>Controller Power LAN Contacts Front door Front door Spare parts Dimension weight</p>	<p>1 BACS WEBMANAGER BUDGET 1 12V Power supply (100 – 240V, 50/60Hz) 1 CAT 6 Ethernet socket 1 Alarm contact (potential-free), 230VC / 30VDC / 8A 1 POWER LED 1 BACS ALARM LED 6 Spare bus communication cable WHD 400 x 500 x 210 mm = 15,75 x 19,69 x 8,27 in. kg 16,10</p>
	<p><b>BACS® CONTROL CABINET Type 2</b> Order No. BACS_CC2</p>	
	<p>Controller Power LAN Contacts Front door Front door Spare parts Dimension weight</p>	<p>2 BACS WEBMANAGER BUDGET 2 12V Power supply (100 – 240V, 50/60Hz) 2 CAT 6 Ethernet socket 2 Alarm contact (potential-free), 230VC / 30VDC / 8A 2 POWER LED 2 BACS ALARM LED 8 spare bus communication cable WHD 500 x 500 x 210 mm = 19,69 x 19,69 x 8,27 in. kg 20,20</p>



	<b>BACS® CONTROL CABINET Type 3</b>	
	Order No. BACS_CC3	
	Controller	3 BACS WEBMANAGER BUDGET
	Power	3 12V Power supply (100 – 240V, 50/60Hz)
	LAN	3 CAT 6 Ethernet socket
	Contacts	3 Alarm contact (potential-free), 230VC / 30VDC / 8A
	Front door	3 POWER LED
	Front door	3 BACS ALARM LED
	Spare parts	10 Spare bus communication cable
	Dimension	WHD 500 x 500 x 210 mm = 19,69 x 19,69 x 8,27 inch
	weight	kg 22,70

BACS Plus Size BACS Control Cabinets are also available as:

<b>BACS® CONTROL CABINET Type 4</b> Order No. BACS_CC4	<b>BACS® CONTROL CABINET Type 5</b> Order No. BACS_CC5	<b>BACS® CONTROL CABINET Type 6</b> Order No. BACS_CC6
- 4 * BACS WEBMANAGER BUDGET	- 5 * BACS WEBMANAGER BUDGET	- 6 * BACS WEBMANAGER BUDGET
- 4 * 12V Power 100 – 240V, 50/60Hz	- 5 * 12V Power 100 – 240V, 50/60Hz	- 6 * 12V Power 100 – 240V, 50/60Hz
- 4 * CAT 6 Ethernet socket	- 5 * CAT 6 Ethernet socket	- 6 * CAT 6 Ethernet socket
- 4 * Alarm contact (potential-free) 230VC, 30VDC, 8A	- 5 * Alarm contact (potential-free) 230VC, 30VDC, 8A	- 6 * Alarm contact (potential-free) 230VC, 30VDC, 8A
- 4 * POWER LED, - 4 * BACS ALARM LED	- 5 * POWER LED, - 5 * BACS ALARM LED	- 6 * POWER LED, - 6 * BACS ALARM LED
12 * spare bus communication cable	14 * spare bus communication cable	16 * spare bus communication cable
- Dimension: 600 x 760 x 210 mm 23,62 x 29,92 x 8,27 in, weight: 38,10 kg	- Dimension: 760 x 760 x 210 mm 29,92 x 29,92 x 8,27 in weight: 48,50 kg	- Dimension: 760 x 760 x 210 mm 29,92 x 29,92 x 8,27 in weight: 55,40 kg

Also available: BACS Control Cabinet with a full featured Windows Touch Panel All-In-One Computer\*

	<p>RAM 1*204-pin SODIMM DDR3L 1333MHz / up to 8GB</p> <p>CPU Intel Bay Trial J1900 Quad Core 2GHz</p> <p>Touch Panel 15" XGA TFT multi-point capacitive touch screen</p> <p>USB 4* USB Ports and 1 covered USB Service Port</p> <p>COM 6 COMPorts</p> <p>LAN 2 GLAN P</p> <p>Wireless 1 x Mini-PCIe slot, extensible 3G,Wifi wireless card</p> <p>Power Consumption (max) 38,6 Watt max</p> <p>Input voltage DC 12V, support reverse polarity protection</p> <p>Graphic Software VGA/HDMI Windows 10 Professional English Language BACS Tools Software packet pre-installed</p> <p>Operating Condition -30 ~80°C (-22~176°F)</p> <p>Relative humidity 5~95% (Non condensation)</p> <p>EMC CD/FCC Class A</p> <p>Notes: The Operating system is a fully featured Windows 10 operating system and needs additional configuration work. not pre-configured – you need to configure it before first use.</p>
---	--





How to order your BAC CC with Touch Panel PC:	
1 BACS WEBMANAGER + PC	BACS_CC1_TP
2 BACS WEBMANAGER + PC	BACS_CC2_TP
3 BACS WEBMANAGER + PC	BACS_CC3_TP
4 BACS WEBMANAGER + PC	BACS_CC4_TP
5 BACS WEBMANAGER + PC	BACS_CC5_TP
6 BACS WEBMANAGER + PC	BACS_CC6_TP

\*for more information, contact, please contact the GENEREX sales team with [sales@generex.de](mailto:sales@generex.de).